

# SKF SYSTEM 24

## Single point automatic lubricator LAGE 125 and LAGE 250

### Reliable, reusable lubricator system meets many needs

The LAGE series of the SKF SYSTEM 24 family are single point electro mechanical driven automatic lubricator systems. Suitable for a wide range of applications and operating conditions, the units are reliable and flexible in operation. Supplied ready to use straight from the box and ease of installation makes the units a perfect complement to the comprehensive range of SKF automatic lubricators.

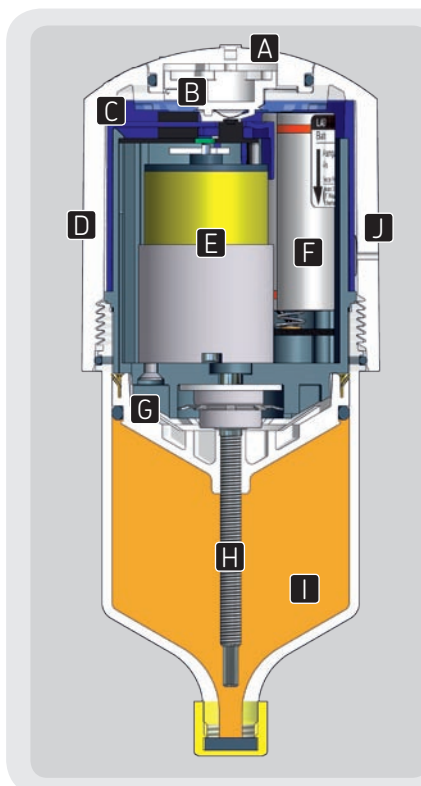

**A B On/off knob and time setting dial**  
Enable easy activation and dial setting

**C LED status indicators**  
Helps verify operating status

**D Drive cover**  
Easily removable, seals and helps prevent ingress of dirt and moisture

**E Electric motor and gearbox**  
Helps enable constant discharge pressure

**F Battery pack**

**G Piston**  
Special piston shape helps ensure optimum emptying of lubricator

**H Spindle**  
Rotates to drive piston, enabling lubricant to be dispensed

**I Lubricant canister**  
Filled with high quality SKF lubricant

**J Anti-vacuum membrane**  
Helps prevent vacuum forming

- Electro mechanical driven makes the unit highly reliable in operation
- Available in two sizes: 122 ml (LAGE 125) and 250 ml (LAGE 250) to suit most bearing lubrication applications
- Remote mounting up to 3 meters (10 ft) for grease filled units and 5 meters (16 ft) for oil filled units allows lubrication of bearings in areas with high ambient temperatures, vibration or hazardous environments
- Available filled with various high quality SKF greases and oils, to suit a wide range of bearing applications
- Refill sets consisting of a canister filled with SKF Grease or Oil and a battery pack help ensure reliable lubricator operation
- Flexible user adjustable dispense settings of 1, 3, 6, 9 or 12 months for use in many different applications
- Ingress protection to IP 65 level allows the lubricator to be used in many dusty and wet environments.
- Temperature independent dispense rate, suitable for use in applications with changing temperatures
- Unlike gas powered units, a maximum discharge pressure of 5 bar can be achieved over the whole lubricant dispensing period
- Easy activation using a clearly marked dial helps minimize setting errors
- Transparent lubricant container allows visual inspection of dispense rate, whilst electro mechanical functions are indicated by simple red-green LED indicators.
- UL listed
- Wide range of accessories is available
- SKF SYSTEM 24 LAGE series is fully featured in SKF DialSet 4.0



Re-lubrication



## Ordering guide

Lubricant	Description	Product	Complete designation
<b>Greases</b>			
LGWA 2	Multi-purpose EP type grease	Complete unit 125 Complete unit 250 Refill set 125 Refill set 250	LAGE 125/WA2 LAGE 250/WA2 LGWA 2/EML125 LGWA 2/EML250
LGEM 2	High loads, slow rotations	Complete unit 125 Complete unit 250 Refill set 125 Refill set 250	LAGE 125/EM2 LAGE 250/EM2 LGEM 2/EML125 LGEM 2/EML250
LGHB 2	High temperature, loads, plain bearing	Complete unit 125 Complete unit 250 Refill set 125 Refill set 250	LAGE 125/HB2 LAGE 250/HB2 LGHB 2/EML125 LGHB 2/EML250
LGHP 2	High performance polyurea	Complete unit 125 Complete unit 250 Refill set 125 Refill set 250	LAGE 125/HP2 LAGE 250/HP2 LGHP 2/EML125 LGHP 2/EML250
LGFP 2	Food processing industry	Complete unit 125 Complete unit 250 Refill set 125 Refill set 250	LAGE 125/FP2 LAGE 250/FP2 LGFP 2/EML125 LGFP 2/EML250
<b>Oils</b>			
LHMT 68	Medium temperature oil	Complete unit 125 Complete unit 250 Refill set 125 Refill set 250	LAGE 125/HMT68 LAGE 250/HMT68 LHMT 68/EML125 LHMT 68/EML250
LHHT 265	High temperature oil	Complete unit 125 Complete unit 250 Refill set 125 Refill set 250	LAGE 125/HHT26 LAGE 250/HHT26 LHHT 265/EML12 LHHT 265/EML25
LHFP 150	Food compatible, NSF H1 approved oil	Complete unit 125 Complete unit 250 Refill set 125 Refill set 250	LAGE 125/HFP15 LAGE 250/HFP15 LHFP 150/EML12 LHFP 150/EML25



## Technical data

Designations		LAGE 125 / LAGE 250
Grease capacity	LAGE 125	122 ml (4,1 fl. oz US)
	LAGE 250	250 ml (8,5 fl. oz US)
Emptying time	User adjustable: 1, 3, 6, 9 and 12 months	
Ambient temperature range	0 °C (-10°C peak ) to 50 °C (32 °F (14 °F peak) to 122 °F)	
Maximum operating pressure	5 bar (75 psi)	
Drive mechanism	Electro mechanical	
Connection thread	R 1/4	
Maximum feed line length with:	grease	Up to 3 meters (10 ft) *
	oil	Up to 5 meters (16 ft)
LED status indicators	operating, purging lubricant, empty, malfunction	

UL certification	UL listed T code 59°C - Category BAYZ – 92UM Lubricant dispensing equipment for use in hazardous locations Class I, Division II, Group A, B, C, D Class II, Division II, Group F &G Class III IP 65	
Protection class assembled lubricator	IP 65	
Battery pack	4,5V 2,7 Ah - Alkaline manganese	
Recommended storage temperature	20 °C (70 °F)	
Storage life of lubricator	3 years ** (2 years for LGFP 2 and Oils)	
Total weight	LAGE 125	635 g (22,5 oz)
	LAGE 250	800 g (28,2 oz)

\* The maximum feed line length is dependent on ambient temperature, grease type and back pressure created by the application.

\*\* Storage life is 3 years from production date, which is printed on the side of the canister.

The canister and battery pack may be used even at 12 months setting if activated 3 years from production date.



## Ordering details accessories SKF SYSTEM 24

Designation	Description	Designation	Description
LAPA 45	Angle connection 45°	LAPN 3/8	Nipple G 1/4 – G 3/8
LAPA 90	Angle connection 90°	LAPN 6	Nipple G 1/4 – M6
LAPB 3x4E1 *	Brush 30 × 40 mm	LAPN 8	Nipple G 1/4 – M8
LAPB 3x7E1 *	Brush 30 × 60 mm	LAPN 8x1	Nipple G 1/4 – M8 × 1
LAPB 3x10E1 *	Brush 30 × 100 mm	LAPN 10	Nipple G 1/4 – M10
LAPB 5-16E *	Elevator brush, 5 – 16 mm gap	LAPN 10x1	Nipple G 1/4 – M10 × 1
LAPB D2 *	Brush round Ø 20 mm	LAPN 12	Nipple G 1/4 – M12
LAPC 13	Bracket	LAPN 12x1.5	Nipple G 1/4 – M12 × 1,5
LAPC 63	Clamp	LAPP 63	Support flange
LAPE 35	Extension 35 mm	LAPP 63V	Support flange with non-return valve
LAPE 50	Extension 50 mm	LAPT 1000	Flexible tube, 1 000 mm long, 8 × 6 mm
LAPF F1/4	Tube connection female G 1/4	LAPT 5000	Flexible tube, 5 000 mm long, 8 × 6 mm
LAPF M1/4	Tube connection male G 1/4	LAPV 1/4	Non return valve G 1/4
LAPF M1/8	Tube connection male G 1/8	LAPV 1/8	Non return valve G 1/8
LAPF M3/8	Tube connection male G 3/8	LAGE 1-BAT	Battery pack
LAPG 1/4	Grease nipple G 1/4		
LAPM 2	Y-connection		
LAPN 1/8	Nipple G 1/4 – G 1/8		
LAPN 1/2	Nipple G 1/4 – G 1/2		
LAPN 1/4	Nipple G 1/4 – G 1/4		
LAPN 1/4UNF	Nipple G 1/4 – 1/4 UNF		

\* Suitable for use with oil filled SKF SYSTEM 24 LAGE 125 and 250 units only

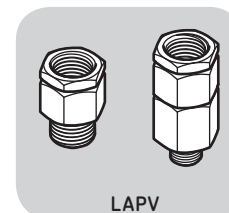
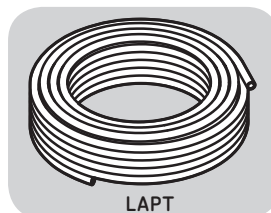
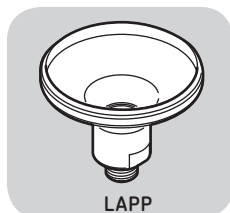
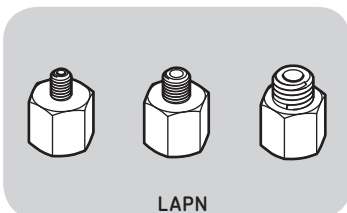
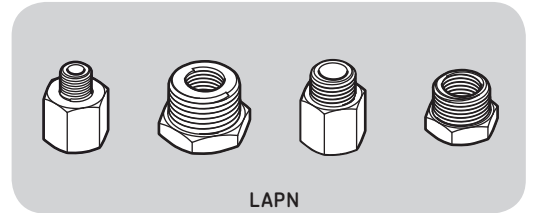
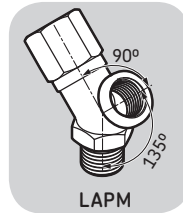
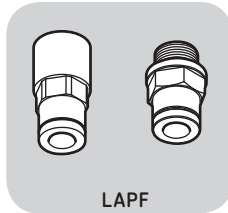
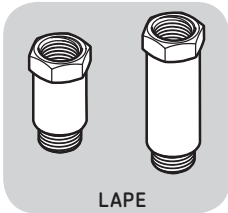
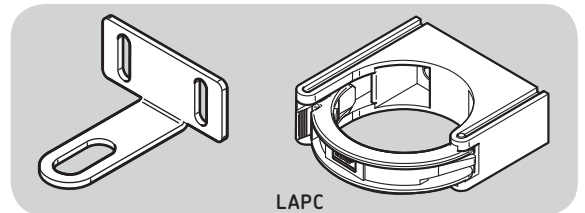
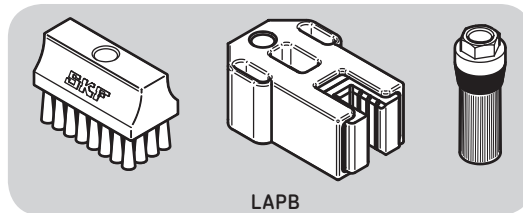
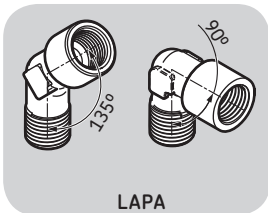

© SKF is a registered trademark of the SKF Group

© SKF Group 2009

The contents of this publication are the copyright of the publisher and may not be reproduced (even extracts) unless prior written permission is granted. Every care has been taken to ensure the accuracy of the information contained in this publication but no liability can be accepted for any loss or damage whether direct, indirect or consequential arising out of the use of the information contained herein.

MP/PDS LAGE EN • October 2009

[www.mapro.skf.com](http://www.mapro.skf.com) • [skf.com/mount](http://skf.com/mount) • [skf.com/lubrication](http://skf.com/lubrication)



## How to contact your authorised distributor

### Distribution Centres

#### Rotherham CDC

**T** 0845 602 9946

**F** 01709 789 988

**E** [sales@acorn-ind.co.uk](mailto:sales@acorn-ind.co.uk)

**W** [www.acorn-ind.co.uk](http://www.acorn-ind.co.uk)

#### Midlands RDC

**T** 0121 521 5999

**F** 0121 521 5888

**E** [midlands@acorn-ind.co.uk](mailto:midlands@acorn-ind.co.uk)

**W** [www.acorn-ind.co.uk/midlands](http://www.acorn-ind.co.uk/midlands)

#### North East RDC

**T** 0191 417 8899

**F** 0191 419 0001

**E** [northeast@acorn-ind.co.uk](mailto:northeast@acorn-ind.co.uk)

**W** [www.acorn-ind.co.uk/northeast](http://www.acorn-ind.co.uk/northeast)

#### South West RDC

**T** 01179 820 414

**F** 01179 823 222

**E** [southwest@acorn-ind.co.uk](mailto:southwest@acorn-ind.co.uk)

**W** [www.acorn-ind.co.uk/southwest](http://www.acorn-ind.co.uk/southwest)

### Regional Branches

#### North West Branch

**T** 0845 602 3568

**F** 01229 833 510

**E** [northwest@acorn-ind.co.uk](mailto:northwest@acorn-ind.co.uk)

**W** [www.acorn-ind.co.uk/northwest](http://www.acorn-ind.co.uk/northwest)

#### Scotland Branch

**T** 01506 476 199

**F** 01506 462 655

**E** [scotland@acorn-ind.co.uk](mailto:scotland@acorn-ind.co.uk)

**W** [www.acorn-ind.co.uk/scotland](http://www.acorn-ind.co.uk/scotland)

### Divisions

#### Export Division

**T** +44 1709 789 933

**F** +44 1709 789 966

**E** [export@acorn-ind.co.uk](mailto:export@acorn-ind.co.uk)

**W** [www.acorn-ind.co.uk/export](http://www.acorn-ind.co.uk/export)

#### Linear Division

**T** 01709 789 949

**E** [linear@acorn-ind.co.uk](mailto:linear@acorn-ind.co.uk)

**W** [www.acorn-ind.co.uk/linear](http://www.acorn-ind.co.uk/linear)